

GENOME MINING OF A MARINE-DERIVED *STREPTOMYCES* SP. PDH23 ISOLATED FROM SPONGE IN DA NANG SEA FOR SECONDARY METABOLITE GENE CLUSTERS

Le Ngoc Giang¹, Le Thi Hong Minh², Vu Thi Quyen², Nguyen Mai Anh², Nguyen Thi Kim Cuc², Vu Thi Thu Huyen²

¹Institute of Biotechnology, Vietnam Academy of Science and Technology

²Institute of Marine Biochemistry, Vietnam Academy of Science and Technology

✉To whom correspondence should be addressed. E-mail: huyenvuibt@gmail.com

Received: 27.4.2020

Accepted: 22.6.2020

SUMMARY

The *streptomyces* is one of the best characterized ubiquitous filamentous bacteria from the actinobacteria class. They are known to produce thousands of specialized metabolite biosynthesis gene clusters (SMBG). Their SMBG clusters have multiple activities ranging from antimicrobial, antitumor, antiviral and probiotic. *Streptomyces* strain and their isolates with interesting biological activities against gram-positive and gram-negative indicator strains was recently characterised. Currently, they are employed in more than half of all antibiotics used in human and veterinary medicine. With the increase in drug resistance bacteria, it is important to mine for new natural chemicals. In this study, screening via disk-diffusion agar method revealed that *Streptomyces* sp. PDH23 isolated from the *Rhabdastrellaglobostellata* marine sponge sample from Da Nang, Vietnam produce antimicrobial agents with a wide spectrum of activities. This species can produce highly active enzymes, which breakdown celluloses, amyloses and proteins. On top of that they are shown to restrict the grow of the gram positive *Bacillus cereus* ATCC14579 (BC), *Staphylococcus aureus* ATCC25923 (SA), the gram-negative *Vibrio parahaemolyticus* ATCC17802 (VP) and the *Candida albicans* ATCC10231 fungus (CA). They are antimethicillin-resistant *S. aureus* (MRSA) ATCC33591 and methicillin-resistant *S. epidermidis* (MRSE) ATCC35984. The taxonomy of PDH23 was characterized using 16S rRNA analysis. Whole genome sequencing of PDH23 showed 8594820 base pairs with GC content of 72.03%. Mining of secondary metabolites reveals gene clusters responsible for the biosynthesis of known and/or novel secondary metabolites, including different types of terpene, NRPS-like, PKS, PKS-like, hglE-KS, betalactone, melanin, t1pks, t2pks, t3pks, nrps, indole, siderophore, bacteriocin, ectoine, butyrolactone, phenazine.

Keywords: *AntiSMASH, genome-mining, marine-actinomyces, sponge-associated, streptomyces.*

INTRODUCTION

Marine sponges are filter feeders and may contain about 10^5 - 10^6 bacteria/ml. Other found species including bacteria, archaea, microalgae, and fungi (Taylor *et al.*, 2007). Sponge-associated microorganisms would comprise around 50% of the sponge biomass, with many

of them are significant for the communities (Koopmans *et al.*, 2009; Brinkmann, 2017). In recent years, researchers have found that many of the biological compounds that were previously thought to belong to the sponges were in fact produced by the microorganisms within the sponge. These findings help to guide the focus on sponge-associated microorganisms

(Lee, 2001).

Evidences suggest that sponges have the ability to select specific microorganisms, those are beneficial for their survival. The *actinomycetes* are generally not harmful and can produce a lot of biologically active metabolites and so a great symbiont for the sponge (Xiet *et al.*, 2012; Selvin *et al.*, 2016).

The exploration of microorganisms capable of producing useful active compounds is of great interest. Nowadays, genome mining is a new strategy for the identification of natural products based on gene cluster sequences and biosynthetic pathways. The genome of *streptomycetes* allows us to explore their biosynthetic potential. Several useful compounds have been identified by studying the genome of *streptomycetes* (Yu *et al.*, 2018). However, up to date, there are limited number of studies on the *streptomycetes* genomes. Using information about gene sequences involved in production of known useful compounds can help to detect and acquire new pathways with such activity. Our report shows that the *Streptomyces* sp. PDH23 from the sea sponge might be the source of several highly bioactive compounds.

MATERIALS AND METHODS

Sampling of sponge

Sponge samples were collected by SCUBA diving at Da Nang, Viet Nam.

Isolation of pure strain

The sponge samples were washed three times with sterile autoclaved artificial seawater, dried in a drain in 5–10 mins. The sample was cut into small pieces and approximately 1 gram. Small pieces of sponge tissue was dissected and grinded using sterile autoclaved artificial sea water. Serially diluted homogenate was spread on to isolation SCA medium containing (g/L): soluble starch 10.00, casein (vitamin free) 0.30, KNO₃: 2.00, MgSO₄.7H₂O: 0.05, K₂HPO₄: 2.00, NaCl: 2.00, CaCO₃: 0.02, FeSO₄.7H₂O: 0.01,

agar: 18.00, sterile autoclaved artificial seawater: 1000 ml, pH (at 25°C) 7.0 ± 0.1. The medium was supplemented with nystatin 25 µg/ml). After repeated streaking for obtaining pure culture, the clear colony of *Streptomyces* sp. PDH23 was collected and inoculated in 2 ml flask containing A1 medium containing (g/L): soluble starch 10.00, yeast extract: 4, peptone: 2, sterile autoclaved artificial seawater: 1000 ml pH (at 25°C) 7.0 ± 0.1) medium at 30 °C with 150rpm shaking for about 7 days. Strain was stored in A1 medium containing glycerol 20% (v/v) at 4 °C for short-term storage, at -20 °C for long-term storage.

Identification and phylogeny

Genomic DNA of *Streptomyces* sp. PDH23 was isolated using HiPurA™ *Streptomyces* DNA Purification Kit following the manufacturer's instructions.

The DNA yield and quality were assessed using 1.0% (w/v) agarose gel electrophoresis. The primer pair 27F (5'-AGAGTTTGATCCTGGCTCAG-3') and 1492R (5'-TACGGCTACCTTGTTACGACTT-3') were used for PCR amplification of 16S rRNA. The PCR was performed in a final volume of 50 µL, which was composed of template DNA: 10 ng, 1.5 mM MgCl₂, 0.2 mM of each dNTP, 200 pM of primer, and 2U of Taq DNA polymerase with the appropriate reaction buffer under the following conditions: initial denaturation at 94 °C for 4 min, followed by 32 cycles of 94 °C for 1 min, annealing at 56 °C for 50 sec, and 72 °C for 1 min 40 sec. The amplification products were separated by gel electrophoresis in 1% agarose gel. The PCR products were then sequenced using the Sanger sequencing platform. Mega 6.0 with bootstrap 1000 was used to demonstrate an evolutionary phylogenetic relationship.

Antibacterial and antifungal activity was determined by agar well diffusion method

Strains of bacterial VP; SA; BC and the yeast CA, MRSA, MRSE obtained from American Type Culture Collection (ATCC,

Manassas, VA), were used in this antimicrobial screening. The agar plate surface is inoculated by spreading a volume of the bacteria inoculum over the entire agar surface. Then, a hole with a diameter of 6 mm is punched aseptically with a sterile tip, and 50 μ L of the *Streptomyces* sp. PDH23 fermentation broth (as antimicrobial agent) is introduced into the well. Then, agar plates are incubated under 37°C overnight. The antimicrobial agent diffuses into the agar medium and inhibits the growth of the microbial strain tested (Magaldi *et al.*, 2004; Valgas *et al.*, 2007; Saadoun, Muhana, 2008).

Screening for enzyme activity

The screening of the actinomycete strains for cellulase/amylase/protease production was studied by inoculating them on SCA (containing 2% substrate (cellulose/amylose/casein)) plates (Fossi *et al.*, 2005) at 30 °C for 72h. Following incubation, plates were flooded with Lugol's iodine solution (1.5% KI, 1% I₂) for 5 mins. Subsequently, the staining solution was poured off and the plates were washed two times with suitable amount of distilled water. The organisms which secrete enzymes, produced zone of clearance or decolorization against the blue color background.

Genome mining

Whole genome sequencing was performed using the Illumina's HiSeq 2000 Sequencing System. Adaptors and low quality reads were removed using bbdut bbtol. Clean reads were assembled *de novo* using SPAdes 3.11.1. Resulting scaffolds were subjected to MEGABLAST against the NCBI nucleotide

database to identify for sequence contaminants, which were removed. The final genome was quality accessed using QUAST and annotation was done using RAST.

Secondary metabolite mining

The assembled scaffolds of the *Streptomyces* sp. were submitted to the antiSMASH server to search for potential secondary metabolite biosynthetic gene clusters. The core structures of secondary metabolite biosynthetic gene clusters were identified by antiSMASH and extracted for comparison with known gene clusters of other species using BLAST.

RESULTS

Collected sample

The sponge sample was collected by SCUBA diving at 14 m depth at location from central coastal region of Da Nang, Viet Nam. They were placed into sterile bottle with 30% glycerol on the ice for the transference to the laboratory. The Yellow pot sponge *Rhabdastrellaglobostellata* was identified based on the morphological characteristics and 28S rRNA by Prof. Dr. Nguyen Thi Kim Cuc.

Isolation and identification of actinomycetes strain

Different concentration of crushed sponge were streak onto SCA agar plate. We have identified 5 strains based on their morphology. Figure below shows the diverse of these strains.

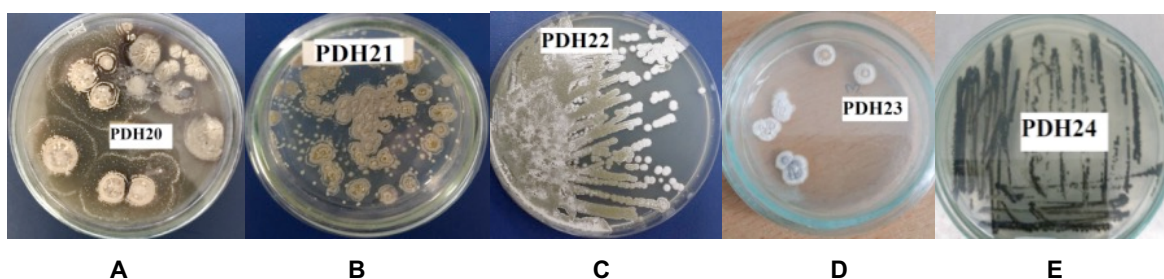

Figure 1. Different strains collected from sponge (A: PDH20 strain; B: A: PDH21; C: PDH22; D: PDH23; E: PDH24).

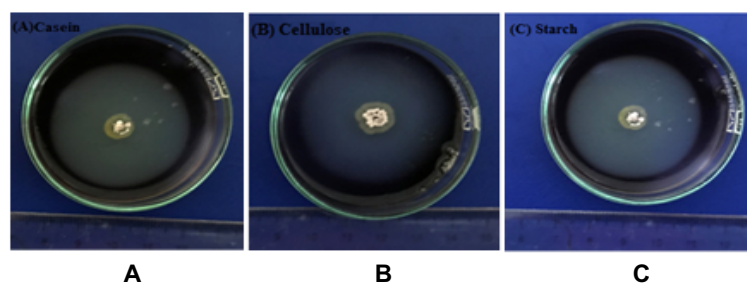

Figure 2. Activity on substrate plates: A. Casein plate. B. Cellulose plate and C. Starch plate.

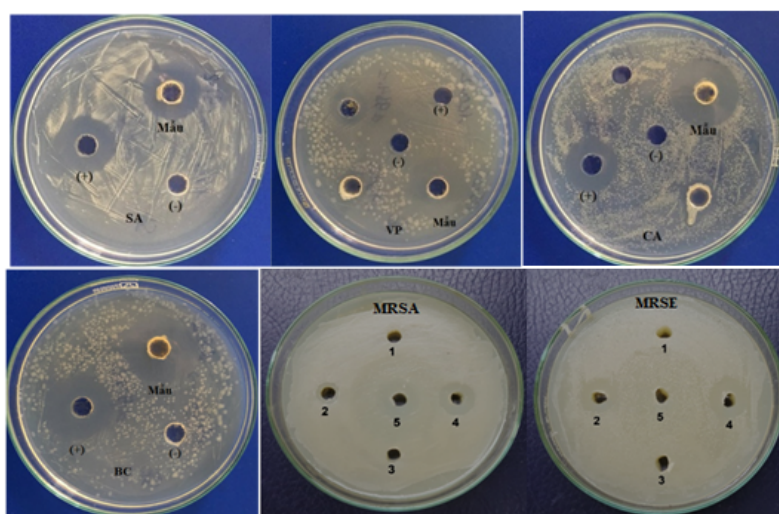

Figure 3. Zone of inhibition test for antimicrobial activity of PDH23 strain on agar plates of. SA; BC; VP and CA; MRSE; MRSA; (+): Positive control. (-): Negative control. (Mau): Sample PDH23. On MRSE and MRSE plates, (4): Sample. (5): Positive control.

Table 1. Antibacterial and antifungal activity of the strain PDH23 versus tested microorganisms.

Substrates: Bacteria/ Fungi	Clear zone of antibacterial activity (mm)	
	sample PDH23	Positive control
<i>Vibrio parahaemolyticus</i> (ATCC17802) VP	18	Chloramphenicol (30 µg) 0
<i>Staphylococcus aureus</i> (ATCC25923) SA	18	Chloramphenicol (30 µg) 22
<i>Bacillus cereus</i> (ATCC14579) BC	19	Chloramphenicol (30 µg) 18
<i>Candida albicans</i> (ATCC1023) CA	18	Nystatin (10 µg/ml) 14
Methicillin-resistant <i>Staphylococcus Aureus</i> (MRSA) ATCC 33591	8,6	Azithromycin (80 µg/ml) 12,1
Methicillin-resistant <i>Staphylococcus epidermidis</i> (MRSE) ATCC 35984	13,9	Azithromycin (80 µg/ml) 0

These strains were tested to see their ability to produce enzymes for the degradation of specific substrates.

As a result (Figure 2) the PDH23 strain had capable of hydrolyzing starch, cellulose and casein with the clear zone diameter correspond to 29; 32 ; 31 mm respectively.

The antibacterial activity of PDH23 strain was tested on pathogenic microorganisms: Two intestinal microorganisms: *B. cereus* and *S. aureus*; one strain of microorganisms causing disease in aquatic products: *V. parahaemolyticus*; one strain of pathogenic fungi on genital tract: *C. albicans* and two strains of antibiotic resistant bacteria: MRSA and MRSE.

Morphology, identify and construct phylogenetic tree for PDH23

Visible appearance showed that the spores are dry, lumpy and have white colour. The filament spores appear to be brown. When cultured in SCA or A1 agar medium, PDH23 strain release colour and dye the surrounding red. The PDH23 strain was cultured in SCA medium for 10 days at 30 °C. Under the SEM (JSM - 5410LV, Japan), the nodular of PDH23 are arranged in a series. The spores are prismatic with a diameter of about 0.5-1 µm with the distance between the nodular is about 1-1.5 µm.

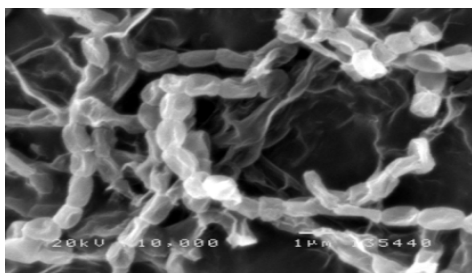

Figure 4. Scanning electron microscope (SEM) of PDH23 strain: Gram-positive, aerobic, filamentous, rod bacterium. They grow as chains of cells and branch to form a network.

The morphology is considered to be one of the most important characteristics in classifying *streptomyces* and it varies greatly between

species. The picture of PDH23 shows that it produces aerial filament spores and the spores are arranged in a sequence. The PDH23 strain may belong to the *streptomyces* genus.

Total DNA of PDH23 strain was obtained by using HiPurA™ *Streptomyces* DNA Purification Kit. The quality of DNA samples was determined using the Nanodrop 2000. The purified isolated DNA had high concentration were used for subsequent studies.

The 16s rRNA gene sequence of the PDH23 strain with 1409 bp was identified and edited using Bioedit software. This strain was classified as *streptomyces* genus and was registered on genbank with the name *Streptomyces* sp. PDH23 with the NCBI accession number MN326756. The PDH23 strain is 98.43% homologous to the 16S rRNA sequence of *Streptomyces* sp. strain R1, which was isolated from lake sediment by Ma at Henan University of Technology, China. From the 16s rRNA gene sequencing data, we generated a phylogenetic tree (Figure 5).

Summary of assembled genome of *Streptomyces* sp. PDH23

The assembled of PDH23 strain genome was registered on NCBI with the accession code SUB5231575. The genome is assembled into 52 contigs with the total size of about 8.5 Mb. The longest contig is 804249 bp. The overall GC content is about 72%. The high GC content have previously been observed in *Streptomycesotsuchiensis* (NCBI accession ASM430597v1). Similarly to PDH23, this strain also has a 72% GC content, but the genome is smaller with only 6.15 Mb. As of writing this article this is the second completed assemble marine genome of *Streptomyces* (Terahara *et al.*, 2019). This assembled genome is highest similarity was to *Streptomyces* sp. KPB2 (NZ_CP034353), which was isolated from kiwifruit, *Streptomyces* sp. CCM_MD2014 (NZ_CP009754.1) from top soil, *Streptomyces* sp. 2114.2 (NZ_LT629768.1) from plants. The genome similarity of these assemblies are shown below.

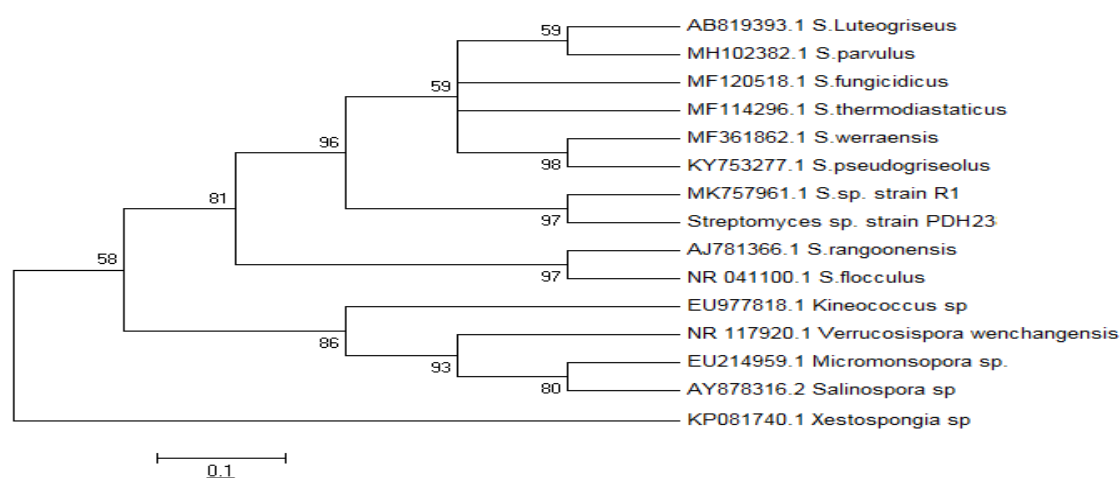

Figure 5. Relation of *Streptomyces* sp. PDH23 to the most 16S rRNA similar. *Xestospongia* sp. 18S rRNA was used as outgroup. The tree topology is based on neighbor joining and built using MEGA6. Bootstrap analysis was performed with 1000 iterations. Only bootstrap values above 50% are displayed. The scale corresponding to the evolutionary distance calculated by using Kimura 2 values.

Table 2. General information of the assembled PDH23.

Assembled	PDH23_scaffolds	Assembled	PDH23_scaffolds
# contigs (≥ 0 bp)	52	# contigs (≥ 0 bp)	52
# contigs (≥ 1000 bp)	52	Total length (≥ 50000 bp)	8327403
# contigs (≥ 5000 bp)	41	Total length (≥ 1000 bp)	8594820
# contigs (≥ 10000 bp)	40	Longest Contig	804249
# contigs (≥ 25000 bp)	38	Total length	8594820
# contigs (≥ 50000 bp)	33	GC (%)	72.03
Total length (≥ 0 bp)	8594820	N50	365348
Total length (≥ 1000 bp)	8594820	N75	183633
Total length (≥ 5000 bp)	8571676	L50	9
Total length (≥ 10000 bp)	8566514	L75	17
Total length (≥ 25000 bp)	8529376	# N's per 100 kbp	2.33

There are 7674 genes transcribed with 7616 genes completing both the opening and ending codes (99.2%), 28 genes lacking the 3' ending (0.4%), 26 genes lacking the 5' heads and only 4 genes lack both. These genes were sent to Blast KOALA with default settings for overall analysis. Then, using the glossary on KEGG, we were able to find related genes and functional clusters.

Genome assembly and annotation

There largest number of genes are in signaling and cellular processing, follows by genetic information processing groups. The metabolism group has the largest number of genes with carbohydrate metabolism as the largest group. The unknown function genes, which does not include in any pathway is the third largest group. There are large interest in

the metabolism and the human diseases as they might contain interesting genes for further analysis.

Secondary metabolite using AntiSMASH

The secondary metabolism of microbe contains biosynthesis pathways such as antibiotics, chemotherapy, insecticides and novel or interesting chemicals. For the discovery of new compounds, these gene encoding clusters such as polyketide synthases (PKSs), lantibiotic synthases and non-ribosomal peptide synthetases (NRPSs) from the bacterial genomes are mined. The contigs of *Streptomyces* sp. PDH23 genome was the input for the antibiotics & Secondary Metabolite Analysis SHell (antiSMASH) server (version 5.0.0), which resulted in 26 predicted gene clusters. Multiple clusters were detected include: Siderophore, nrpsfragment-t1pks, bacteriocin-nrps-terpene, betalactone, nrps, bacteriocin, ectoine, melanin, terpene, type 2 pks, indole, type 3 pks, nrps-nrpsfragment-t1pks, phenazine, butyrolactone, otherks-t1pks-t2pks and otherks were predicted to be encoded in the genome. These results were compared with the MIBiG (Minimum Information about a Biosynthetic Gene cluster) to accurately predict

certain metabolites and/or the most likely class (Table 3).

In comparison to the other genomes, the unknown and others are the two biggest clusters. In general the PDH23 has about the same number of NRPS, Teroene, RiPP and NRP + Polyketide as the other genomes. These numbers are underestimated as the whole genome is divided into multiple contigs, which some truncated. The biochemical results also show more chemicals detected than the number of predicted clusters.

Twelve clusters show more than 80% similarities to known gene clusters: Undecylprodigiosin, geosmin, streptothricin, coelichelin, ectoine, desferrioxamine B, melanin, albaflavenone, hopene, coelibactin, isorenieratene and hedamycin. The most common clusters are ectoine and sideophoredesferrioxamine B, the anti-tumor herboxidine, coelichelin, the carotenoid light-harvesting pigment isorenieratene and the terpene hopene. In comparison to the marine *S. OTB305* (Assembly acc. ASM430597v1) only three gene clusters hopene, ectoine and herboxidiene are similar.

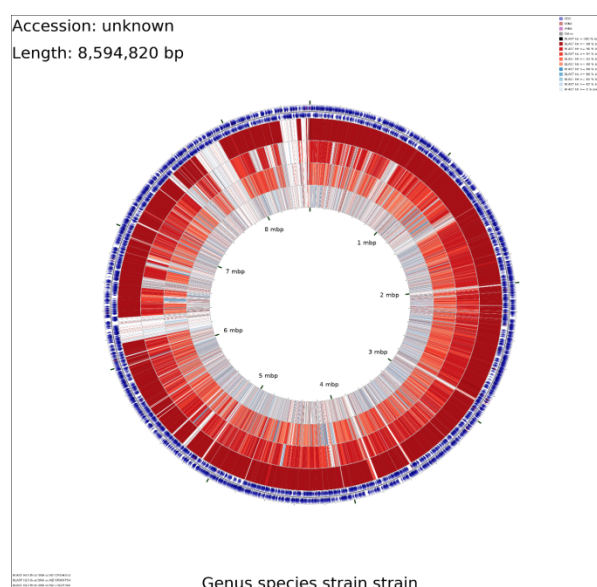

Figure 6. The genome similarity of these assemblies with different *Streptomyces* strains. The darker the colour the more similarity they are against each other.

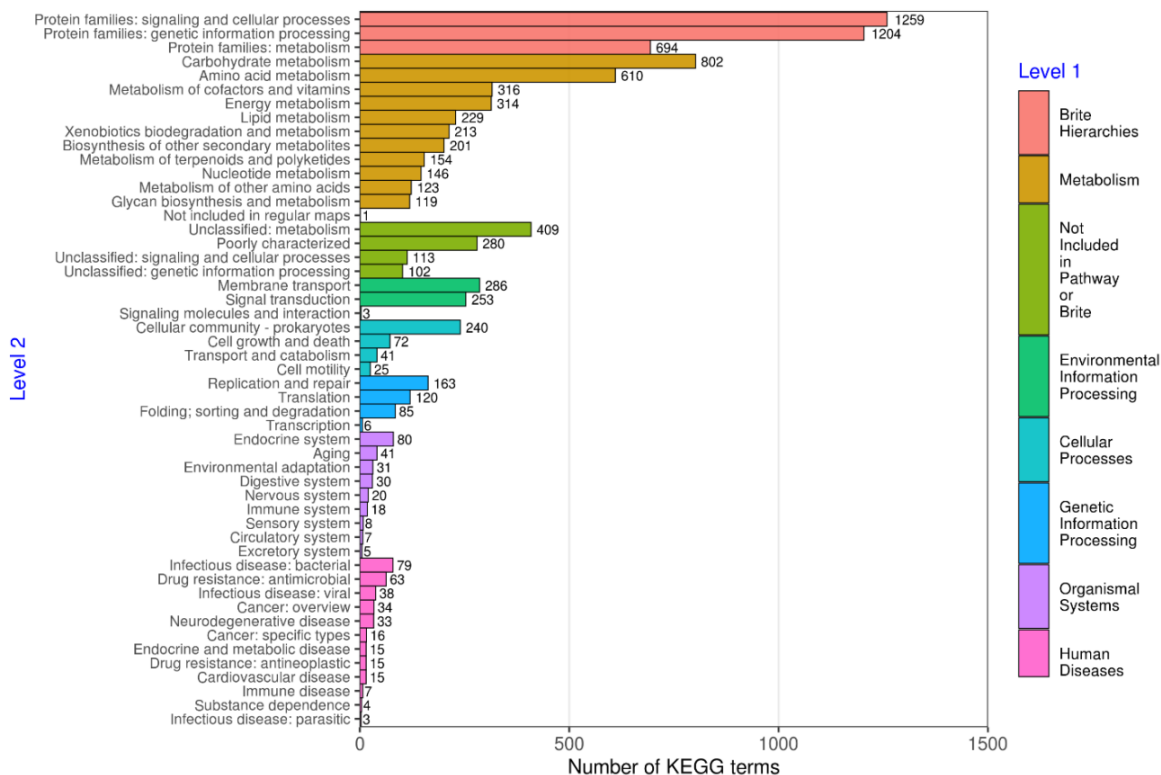

Figure 7. Number of KEGG terms.

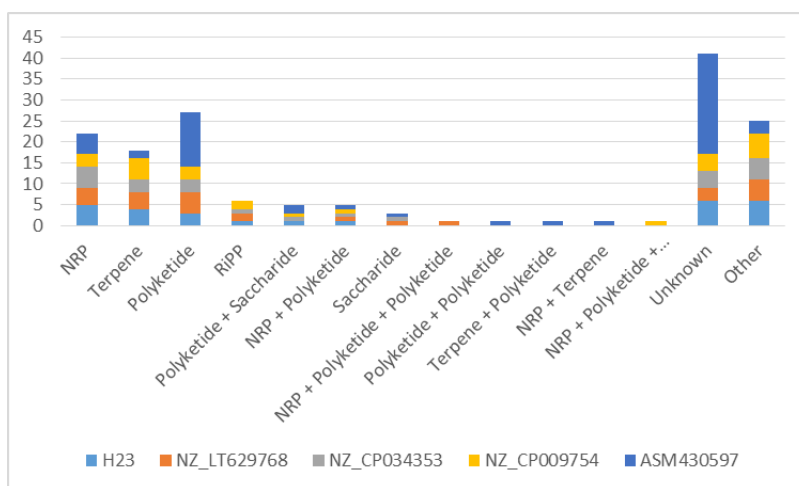

Figure 8. Bar chart of different secondary metabolites produced by 5 different species of *Streptomyces*. Result generated from antiSMASH.

There were three siderophore clusters predicted, with two predicted to be grincamycin (5%) and desferrioxamine B (83%). The

desferrioxamine B is a member of iron-binding molecules called siderophores, which help the bacteria to take up iron from the environment. It

also has antioxidant potential and have been used in clinical for treatment of iron overload(Crichton, 2012; Raines *et al.*, 2015). This is a highly conserved gene cluster in *streptomyces* genera. This gene cluster is 83% gene identical to AL645882.2 from *S. coelicolor* A3(2) and 100% identical to AP009493.1 from *S. griseus subsp. griseus* NBRC 13350. There are 5 main genes including the core siderophore biosynthesis enzyme (lucA_clucC), acetyle transferase, monooxygenase, pyridoxal-dependant dcarboxylase and siderophore-interacting protein.

Streptothricin is a broad spectrum antibiotic

that is produced by *streptomycetes* that affect both gram negative and positive bacteria as well as fungi. It inhibits protein synthesis by preventing the charged tRNAs to the A-site of the ribosome and blocking translocation of the peptidyl-tRNA to the P-site(Stankovic *et al.*, 2014; Burckhardt ,Semerena, 2017). The antibiotic was shown to have effects against *escherichia coli*, *bacillus subtilis*, *staphylococcus aureus*, *bacillus cereus* and *pseudomonas aeruginosa*(Ji *et al.*, 2009).

Hedamycin is an antitumor polyketide antibiotic. It has anticancer activity, the gene cluster is 90%. It was found to be product of *streptomyces griseoruber*(Das, Khosla, 2009).

Table 3. These results were compared with the MIBiG (Minimum Information about a Biosynthetic Gene cluster) to accurately predict certain metabolites and/or the most likely class.

Cluster	Type	Size (bp)	Similar cluster	known	% id	MIBiG BGC-ID
1	Siderophore	11350	-		-	-
2	T1pks-Nrpsfragment	46911	Undecylprodigiosin		100%	BGC0001063
3	Bacteriocin-Nrps-Terpene	73908	Geosmin		100%	BGC0001181
4	Betalactone	27775	Hormaomycin		13%	BGC0000374
5	Siderophore	13239	Grincamycin		5%	BGC0000229
6	Nrps	61228	Streptothricin		87%	BGC0000432
7	Bacteriocin	10215	Informatipeptin		42%	BGC0000518
8	Nrps	51087	Coelichelin		100%	BGC0000325
9	Ectoine	10398	Ectoine		100%	BGC0000853
10	Siderophore	11775	Desferrioxamine B		83%	BGC0000940
11	Melanin	10593	Melanin		100%	BGC0000910
12	Terpene	21013	Albaflavenone		100%	BGC0000660
13	T2pks	72536	Spore pigment		66%	BGC0000271
14	Terpene	26732	Hopene		100%	BGC0000663
15	Indole	21127	Ravidomycin		5%	BGC0000263
16	Terpene	20425	Carotenoid		18%	BGC0000633
17	T3pks	41124	Herboxidiene		8%	BGC0001065
18	T1pks-Nrpsfragment-Nrps	66919	-		-	-
19	Phenazine	20425	-		-	-
20	Nrps	66476	Coelibactin		100%	BGC0000324
21	Butyrolactone	10749	-		-	-

22	Terpene	25538	Isorenieratene		100%	BGC0000664
23	Nrps	35083	Carbapenem 4550	MM	6%	BGC0000842
24	T2pks-Otherks-T1pks	82613	Hedamycin		90%	BGC0000233
25	Otherks	53479	-		-	-
26	Nrps	2819	-		-	-

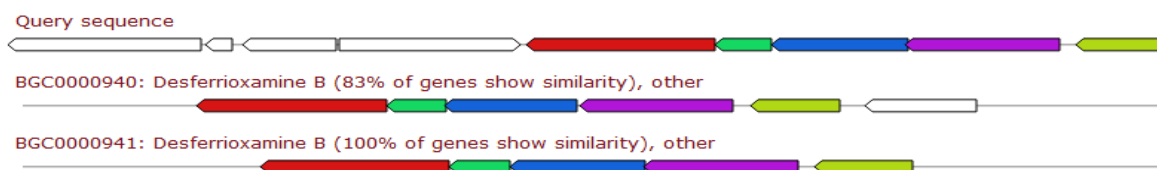

Figure 9. c00004_NODE_4_- Region 1 – Siderophore Location: 202632 – 214407. The similarity in clustering of Desferrioxamine B in different species. Result generated from antimash.

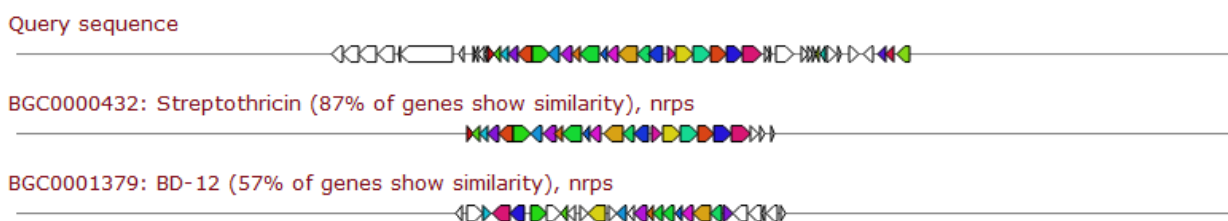

Figure 10. Cluster similarity of nrps with Streptothricin and BD-12.

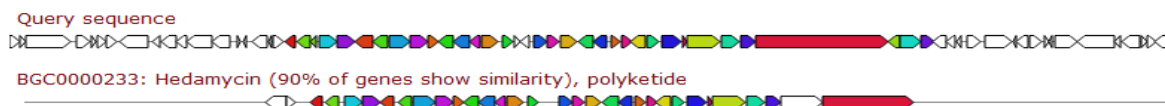

Figure 11. Cluster similarity with Hedamycin. Result generated from antiSMASH.

DISCUSSION

Bioinformatics analysis shows that each strain of bacteria has the ability to synthesize 25-30 types of natural products, of which about 90% is still unknown. Even if only 20% of the 25-30 types of natural products produced by each strain are new structures, the number of new natural products we obtain will increase exponentially (Winter *et al.*, 2011; Liet *et al.*, 2018).

Marine *actinomycetes* are a potential source of novel compounds because their environments are completely different from those on land. Many researchers have isolated new antibiotics

from the marine environment (Maskey *et al.*, 2003; Sujatha *et al.*, 2005). The *actinomycetes* produce many enzyme inhibitors, antibiotics and anti-cancer. Marine *actinobacteria* are good sources of enzyme inhibitors (Imada, 2005). According to (Peela *et al.*, 2005) many types of marine *actinomycetes* were isolated from samples collected from the Andaman coast in the bay of Bengal and most of the isolates of the genus *streptomyces* had antibacterial and antifungal activity. *Streptomyces* have been shown to be capable of synthesizing antibacterial agents (Ramesh, Mathivanan, 2009), antifungal agents (Prapagdee *et al.*, 2008; Ramesh, Mathivanan, 2009; Xu *et al.*,

2010), drugs insecticide (Elardo *et al.*, 2010), anticancer(Lam, 2006; Hong *et al.*, 2009), anti inflammatory agent (Renner *et al.*, 1999), antiparasitic agent (Elardo *et al.*, 2010), anti-infection agents (Rahman *et al.*, 2010), many other agents such as enzyme inhibitors(Hong *et al.*, 2009) and vitamins(Atta, 2007). Furthermore, they are well known for their abilities to produce extracellular carbohydrate enzymes including ribonucleases (Hong *et al.*, 2009; Ramesh, Mathivanan, 2009).

CONCLUSION

In this study, we isolated, identified and studied *Streptomyces* sp. PDH23 (Registration number on genbank MN326756), which is a symbiotic association with the *Rhabdastrella globostellata* sponge specimen resided at the coastal areas of Da Nang, Vietnam. The PDH23 showed the high ability to produce enzymes and this strain exhibited quite strong inhibition some strains of pathogenic microorganisms. The entire genome sequence of the PDH23 strain was decoded with a total length of 8594820 bp with a GC content of 72.03%. The genome of the PDH23 has also been registered on NCBI with the code SUB5231575. Using software to exploit secondary metabolites shows that gene clusters are responsible for biosynthesis of known and / or new secondary metabolites, including various terpene types, such as NRPS, PKS, hglE-KS, betalactone, melanin, T1pks, T2pks, T3 Nrps, indole, siderophore, acteriocin, ectoine, butyrolactone, phenazine. These results show the potential for producing highly bioactive compounds of the PDH23 strain.

Acknowledgements: *This research is funded by Graduate University of Science and Technology - Vietnam Academy of Science and Technology, under grant number GUST. STS.ĐT2017-SH01.*

REFERENCES

Atta HM (2007) Production Of Vitamin B₁₂ By *Streptomyces Fulvissimus*. *Egypt J Biomed Sci* 23(1):

166–184.

Biabani MA, LaatschH, HelmkeE, WeylandH (1997) δ -indomycinone: A new member of pluramycin class of antibiotics isolated from marine *Streptomyces* sp.. *J Antibiot* 50(10): 874–877.

Brinkmann CM, Marker A, Kurtböke DI (2017) An overview on marine sponge-symbiotic bacteria as unexhausted sources for natural product discovery. *Diversity* 9(4): 40.

Burckhardt RM, Semerena JC (2017) In *Bacillus subtilis*, the SatA (formerly YyaR) acetyltransferase detoxifies streptothricin via lysine acetylation. *Appl Environ Microbiol* 83(21): 01590-17.

Crichton R (2012) *Biological Inorganic Chemistry, Biological Inorganic Chemistry*. Elsevier.

Das A, Khosla C (2009) In Vivo and In Vitro Analysis of the Hedamycin Polyketide Synthase. *Chem Biol* 16(11):1197–1207.

Fossi BT, Tavea F, Ndjouenkeu R (2005) Production and partial characterization of a thermostable amylase from ascomycetes yeast strain isolated from starchy soils. *Afric J Biotechnol* 4(1): 14–18.

Higginbotham SJ, Murphy CD (2010) Identification and characterisation of a *Streptomyces* sp. isolate exhibiting activity against methicillin-resistant *Staphylococcus aureus*. *Microbiol Res* 165(1):82–86.

Hong K, Gao HA, Xie YQ, Gao H, Zhuang L, Lin PH, Yu PH, Li J, Yao SX, Goodfellow M, Ruan SJ(2009) Actinomycetes for marine drug discovery isolated from mangrove soils and plants in China. *Marine Drugs* 7(1): 24–44.

Imada C (2005) Enzyme inhibitors and other bioactive compounds from marine actinomycetes. *Antonie van Leeuwenhoek, Inter J Gener Mol Microbiol* 87(1): 59–63.

Ji Z, Wang M, Wei S, Zhang J, Wenjun W(2009) Isolation, structure elucidation and antibacterial activities of streptothricin acids. *Journal of Antibiotics* 62(5): 233–237. Koopmans M, Martens D, Wijffels RH (2009) Towards commercial production of sponge medicines. *Marine Drugs* 7(4): 787–802.

Lam KS (2006) Discovery of novel metabolites from marine actinomycetes. *Curr Opin Microbiol* 9(3): 245–251.

Lee YK, Lee JH, Lee H K (2001) Microbial Symbiosis in Marine Sponges. *J Microbiol* 39(4): 254–264.

- Li F, Maskey PR, Qin S, Sattler I, Fiebig HH, Maier A, Zeeck A, Laatsch H (2005) Chinikomycins A and B: Isolation, structure elucidation, and biological activity of novel antibiotics from a marine *Streptomyces* sp. isolate M045. *J Nat Prod* 68(3): 349–353.
- Li Z, Zhu D, Shen Y (2018) Discovery of novel bioactive natural products driven by genome mining. *Drug Discover Therapeut* 12(6): 318–328.
- Magaldi S, Essayag S, Capriles C, Perez C, Colellaa TM, Olaizola C, Ontiveros Y (2004) Well diffusion for antifungal susceptibility testing. *Inter J Infect Dis* 8(1): 39–45.
- Maskey RP, Helmke E, Laatsch H (2003) Himalomycin A and B: Isolation and structure elucidation of new fridamycin type antibiotics from a marine *Streptomyces* isolate. *J Antibiot Japan* 56(11): 942–949.
- Peela S, Kurada VVSNB, Terli R (2005) Studies on antagonistic marine actinomycetes from the Bay of Bengal. *World J Microbiol Biotechnol* 21(4): 583–585.
- Elardo PMS, Kozytska S, Bugni ST, Ireland MC, Moll H, Hentschel U (2010) Anti-parasitic compounds from *Streptomyces* sp. strains isolated from Mediterranean sponges. *Marine Drugs* 8(2): 373–380.
- Rahman H, Austin B, Mitchell JW, Morris CP, Jamieson JD, Adams RD, Spragg MA, Schweizer M (2010) Novel anti-infective compounds from marine bacteria. *Marine Drugs* 8(3):498–518.
- Raines DJ, Sanderson TJ, Wilde JE, Klair DKA (2016) *Reference Module in Chemistry, Molecular Sciences and Chemical Engineering* Elsevier.
- Ramesh S, Mathivanan N (2009) Screening of marine actinomycetes isolated from the Bay of Bengal, India for antimicrobial activity and industrial enzymes. *World J Microbiol Biotechnol Springer* 25(12): 2103–2111.
- Renner KM, Shen CY, Cheng CX, Jensen RP, Frankmoelle W, Kauffman AC, Fenical W, Lobkovsky E, Clardy J (1999) Cyclomarins A-C, new antiinflammatory cyclic peptides produced by a marine bacterium (*Streptomyces* sp.). *J Amer Chem Soc* 121(49): 11273–11276.
- Saadoun I, Muhana A (2008) Optimal production conditions, extraction, partial purification and characterization of inhibitory compound(s) produced by *Streptomyces* Ds-104 isolate against multi-drug resistant *Candida albicans*. *Curr Trends Biotechnol Pharm* 2(2): 402–420.
- Selvin J, Sathiyarayanan G, Lipton NA, Al-Dhabi AN, Arasu VM, Kiran SG (2016) Ketide Synthase (KS) domain prediction and analysis of iterative type II PKS gene in marine sponge-associated actinobacteria producing biosurfactants and antimicrobial agents. *Front Microbiol* 7(FEB): 63.
- Stankovic N, Senerovic L, Tomic IT, Branka Vasiljevic B, Runic NJ (2014) Properties and applications of undecylprodigiosin and other bacterial prodigiosins. *Appl Microbiol Biotechnol*: 98(9): 3841–3858.
- Sujatha P, Bapi RKVSN, Ramana T (2005) Studies on a new marine streptomycete BT-408 producing polyketide antibiotic SBR-22 effective against methicillin resistant *Staphylococcus aureus*. *Microbiol Res* 160(2): 119–126.
- Taylor M, Radax R, Steger D, Wagner M (2007) Sponge-Associated Microorganisms: Evolution, Ecology, and Biotechnological Potential. *Microbiol Mole Biol Rev* 71(2): 295–347.
- Terahara T, Naemura T, Nampo Y, Kobayashi T, Imada C, Hamada M, Tamura (2019) *Streptomyces otsuchiensis* sp. nov., a biosurfactant-producing actinobacterium isolated from marine sediment. *Int J Syst Evolut Microbiol Microbiol Soc* 69(12): 3740–3744.
- Valgas C, Souza DMS, Smânia AFE, Smânia JrA (2007) Screening methods to determine antibacterial activity of natural products. *Braz J Microbiol* 38(2): 369–380.
- Winter MJ, Behnken S, Hertweck C (2011) Genomics-inspired discovery of natural products This review comes from a themed issue on Omics Edited. *Curr Opin Chem Biol* 15: 22–31.
- Xi L, Ruan J, Huang Y (2012) Diversity and biosynthetic potential of culturable actinomycetes associated with marine sponges in the China seas. *Int J Mol Sci* 13(5): 5917–5932.
- Xu Y, He H, Schulz S, Liu X, Fusetani N, Xiong H, Xiao X, Qian YP (2010) Potent antifouling compounds produced by marine *Streptomyces*. *Bioresour Technol* 101(4): 1331–1336.
- Yu Y, Tang B, Dai R, Zhang B, Chen L, Yang H, Zhao G, Ding X (2018) Identification of the streptothricin and tunicamycin biosynthetic gene clusters by genome mining in *Streptomyces* sp. strain fd1-xmd. *Appl Microbiol Biotechnol* 102(6): 2621–2633.

KHAI THÁC DỮ LIỆU HỆ GEN CỦA CHỦNG *STREPTOMYCES* SP. PDH23 CỘNG SINH HẢI MIỀN PHÂN LẬP TẠI BIỂN ĐÀ NẴNG CHO CÁC CỤM GEN CÓ HOẠT TÍNH SINH HỌC

Lê Ngọc Giang¹, Lê Thị Hồng Minh², Vũ Thị Quyên², Nguyễn Mai Anh², Nguyễn Thị Kim Cúc², Vũ Thị Thu Huyền²

¹Viện Công nghệ sinh học, Viện Hàn lâm Khoa học và Công nghệ Việt Nam

²Viện Hóa sinh biển, Viện Hàn lâm Khoa học và Công nghệ Việt Nam

TÓM TẮT

Trong nghiên cứu này, chủng xạ khuẩn *Streptomyces* sp. PDH23 được phân lập từ mẫu hải miên *Rhabdastrella globostellata* thu nhận từ vùng biển Đà Nẵng, Việt Nam thể hiện tiềm năng ứng dụng trong y sinh học cao. Chủng PDH23 cho khả năng sinh enzyme cellulase, amylase, proteasetốt. Bên cạnh đó, chủng xạ khuẩn này biểu hiện ức chế sinh trưởng với 2 chủng vi khuẩn Gram (+) BC(ATCC25923), với 1 chủng vi khuẩn Gram (-) VP(ATCC17802) và chủng nấm men CA (ATCC10231). Ngoài ra, chủng PDH23 còn cho kết quả khá tốt trong thử nghiệm hoạt tính kháng hai chủng vi khuẩn kháng thuốc gây bệnh đường ruột là MRSA (ATCC33591) và MRSE (ATCC35984). Trình tự bộ gen của chủng xạ khuẩn PDH23 đã được giải mã có tổng độ dài 8594820 bp với hàm lượng GC là 72,03%. Có 7674 gen được phiên mã với 7616 gen hoàn thành cả mã mở đầu và mã kết thúc (99,2%), 28 gen thiếu đầu kết thúc 3' (0,4%), 26 gen thiếu đầu 5' và chỉ có 4 gen thiếu cả hai. Những gen này đã được gửi đến Blast KOALA với các cài đặt mặc định để phân tích tổng thể. Nghiên cứu đã sử dụng các phần mềm khai thác hợp chất chuyển hóa thứ cấp cho thấy các cụm gen chịu trách nhiệm sinh tổng hợp các chất chuyển hóa thứ cấp đã biết và/hoặc mới, bao gồm các loại terpene khác nhau, như NRPS, PKS, hglE-KS, betalactone, melanin, T1pks, T2pks, T3 Nrps, indole, siderophore, acteriocin, ectoine, butyrolactone, phenazine có tiềm năng tạo ra các hợp chất có hoạt tính sinh học cao của chủng xạ khuẩn PDH23.

Từ khóa: *AntiSMASH, genome-mining, marine-actinomyces, sponge-associated, streptomyces.*